

APPLICATION

For the use of direct flood and/or accent lighting. To install as an above grade fixture. Perfect for applications desiring a dynamic color changing effect. Recommended for retail, modern residential, hospitality and entertainment installations. RGBW design allows fine-tuned pastel colors, saturated hues without sacrificing illumination brightness.

- 80W (10-LED) 2,500 Max. Lumen
- DMX direct via LCD display.
- Wet location IP65
- Proprietary quick connectors included
- Multiple beam spreads
- LED Die Colors: RGBW
- Static Colors Available
- Using InternaMix™ proprietary technology, colors are efficiently blended together through an internal mixing chamber. The one-color output reduces unsightly views of isolated rainbow-like striations.
- Smooth and flicker-free dimming of all colors down to 1% using patented color mixing and dimming technologies developed at Philips Color Kinetics®
- 3 Year Warranty

DIMENSIONS

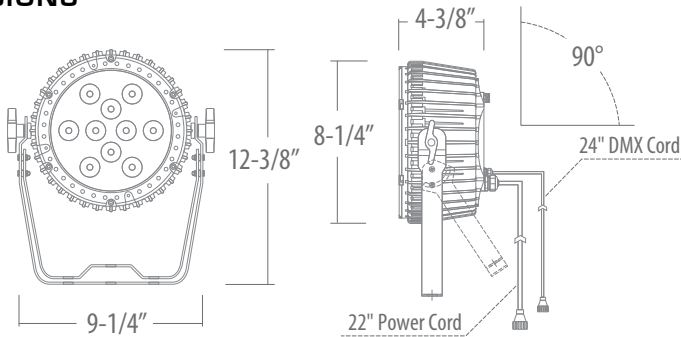

ORDERING – Example: SS2-RGBW-8R-10-B45



HOUSING

SS2-RGBW-8R-10



BEAM SPREAD



- B25: 25° Narrow Flood
- B45: 45° Flood

OPTION

- Blank: None
- VSR: Glare Shield Visor

ACCESSORIES

60" Plug-In Cord For connecting mains power to unit. Terminated in a 15A Male Edison Connector. For other connector options, contact the Factory.	SWR-PWR-WL-60-PI 
80" Power Jumper For daisy chaining power from powered unit to unpowered unit. No more than 6 units max from mains power feed.	SWR-PWR-WL-80 
300" (25') Data Cable Interconnect For daisy chaining DMX from one fixture to another. Pre-terminated in 3-Pin Proprietary connector. Maximum 32 fixtures may be connected on any DMX run. (For bare-end at one end, please specify -HW.)	SWR-DMX-WL-300 

80" DMX/ Data Jumper For daisy chaining DMX from one fixture to another. Pre-terminated in 3-Pin Proprietary connector. Maximum 32 fixtures may be connected on any DMX run. (For bare-end at one end, please specify -HW.)	SWR-DMX-WL-80 
Wet Location Power Endcap Protective cover for use in wet location environments for capping power connector cable.	PCL008-WL-PWR 
Wet Location DMX Endcap Protective cover for use in wet location environments to cap DMX cables. Not a DMX terminator	PCL008-WL-DMX 

SPECIFICATIONS

OUTPUT

Beam Angle: 25° Standard, 45° Optional

Lumens: 2,500 Max. Lumen

Efficacy (lm/W): 31.25 lm/W

LED Channels: Red/Green/Blue/White

ELECTRICAL

Input Voltage: 120V-277V

Power Consumption: 80W

CONTROL

Interface: DMX direct via LCD display

Control System: DirectDMX Color Control. Color controlled with USITT DMX512A Standard Protocol to work with Coloronix or 3rd Party DMX Systems. On board LCD display allow selecting of DMX addresses between 1-512 in a given DMX universe. DMX Data fed to housing via proprietary 3-wire data cable. Data Input/Output ports allow daisy-chaining of DMX Signal.

LED Die Colors: Red (620-635nm), Green (520-535nm), Blue (450-465nm) and Neutral White (4000K)

Static Color Available: All Standard Colors, Consult Factory.

Dimming: Smooth and flicker-free dimming of all colors down to 1% using Patented Color Mixing and Dimming technologies developed at Philips Color Kinetics®

Stand Alone Control: Pre-Programmed static and dynamic scenes, as well as specific colors, can be user activated by the integral Data Enabler's computer eliminating the need for an external data source. On board innovated OLED display inside the Data Enabler allows selecting of over 30 static and dynamic color sequences. Display encased behind temperproof UV protected glass to reduce deterioration after long exposure to outdoor environments.

Color Mixing: Using InternaMix™ proprietary technology, colors are efficiently blended together through an internal mixing chamber. The one-color output reduces unsightly views of isolated Red, Green and Blue Diodes for a seamless rainbow-free appearance.

LUMEN MAINTENANCE

L70 Life: 35,000 Hours for ambient temperatures under 100°F.

PHYSICAL

Dimensions (Height x Width x Length): 12-3/8" x 4-3/8" x 9-1/4"

Housing Material: Die-cast aluminum to protect light emitting diodes, other electronics and preserve optical alignment. Painted black to maximize color mixing and eliminate stray light leaks. Integral split yoke allows for 90° tilt.

Weight: 7.8lbs. (3.55kg)

Lens: PMMA Impact Resistant

Connections: Proprietary miniature 3-pin watertight DMX connection for easy daisy-chain connections up to 2.5 feet on center (32 links max). Proprietary miniature 3-pin watertight Power connectors for easy daisy-chain connections (9 power connections max per power feed).

Mounting: Split yoke provided for pipe, truss or surface mounting. Pre-drilled mounting holes on yoke.

Temperature Range: 14°F - 104°F Ambient

CERTIFICATION

Complies to UL1598 and ANSI/UL 8750. Wet location rated. IP65 protection.

WARRANTY

3-Year Warranty

PHOTOMETRY

FOOTCANDLE CALCULATION: SS2-RGBW-8R-10-B25

Height	FC	Ø @ 50% of beam	Ø @ 90% of beam
10'	99	16'	33'
11'	73	18'	35'
12'	63	20'	40'
15'	40	25'	50'
18'	28	30'	60'

