

APPLICATION

For the use of linear direct flood and/or accent lighting. To install as an above grade fixture. Perfect for applications desiring a dynamic color changing effect. Recommended for retail, modern residential, hospitality and entertainment installations.

- 45W (12-LED) 2,200 Max. Lumen
- DMX direct via LCD display.
- IP66
- Proprietary quick connectors included
- Multiple beam spreads
- LED Die Colors: RGB
- Static Colors Available

- Using InternaMix™ proprietary technology, colors are efficiently blended together through an internal mixing chamber. The one-color output reduces unsightly views of isolated rainbow like striations.
- Smooth and flicker-free dimming of all colors down to 1% using patented color mixing and dimming technologies developed at Philips Color Kinetics®
- 3 Year Warranty

DIMENSIONS

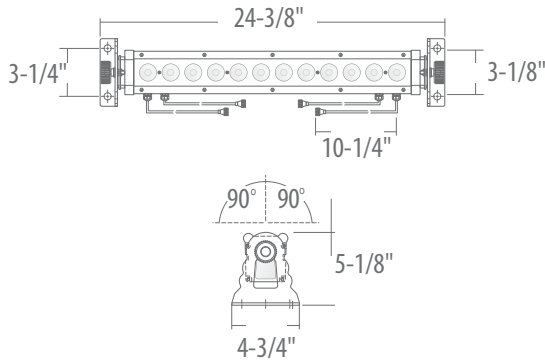

ORDERING – Example: SS2-RGB-3L-12-B45

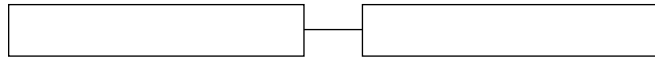

HOUSING



SS2-RGB-3L-12



BEAM SPREAD

- B45: Flood
- B2095: Asymmetrical Flood
- B60: Wide Flood



ACCESSORIES

60" Plug-In Cord For connecting mains power to unit. Terminated in a 15A Male Edison Connector. For other connector options, contact the Factory.	SWR-PWR-WL-60-PI 
80" Power Jumper For daisy chaining power from powered unit to unpowered unit. No more than 6 units max from mains power feed.	SWR-PWR-WL-80 
300" (25') Data Cable Interconnect For daisy chaining DMX from one fixture to another. Pre-terminated in 3-Pin Proprietary connector. Maximum 32 fixtures may be connected on any DMX run. (For bare-end at one end, please specify -HW.)	SWR-DMX-WL-300 

80" DMX/Data Jumper For daisy chaining DMX from one fixture to another. Pre-terminated in 3-Pin Proprietary connector. Maximum 32 fixtures may be connected on any DMX run. (For bare-end at one end, please specify -HW.)	SWR-DMX-WL-80 
Wet Location Power Endcap Protective cover for use in wet location environments for capping power connector cable.	PCL008-WL-PWR 
Wet Location DMX Endcap Protective cover for use in wet location environments to cap DMX cables. Not a DMX terminator	PCL008-WL-DMX 

SPECIFICATIONS

OUTPUT

Beam Angle: 45°, 20° x 95°, 60°

Lumens: 2,200 Max. Lumen

Efficacy (lm/W): 48.8 lm/W

LED Channels: Red/Green/Blue

ELECTRICAL

Input Voltage: Direct 120-277V input comes standard. 50/60 Hz

Power Consumption: 0-45W

CONTROL

Interface: DMX direct via LCD display

Control System: DirectDMX Color Control. Color controlled with USITT DMX512A Standard Protocol to work with Coloronix or 3rd Party DMX Systems such as the Color Kinetics® iPlayer 3. On board LCD display inside the Data Enabler allow selecting of DMX addresses between 1-512 in a given DMX universe. DMX Data fed to housing via proprietary 3-wire data cable. Data Input/Output ports allow daisy-chaining of DMX Signal.

LED Die Colors: Red (620-635nm), Green (520-535nm), Blue (450-465nm)

Static Color Available: All Standard Colors, Consult Factory.

Dimming: Smooth and flicker-free dimming of all colors down to 1% using Patented Color Mixing and Dimming technologies developed at Philips Color Kinetics®

Stand Alone Control: Pre-Programmed static and dynamic scenes, as well as specific colors, can be user activated by the integral Data Enabler's computer eliminating the need for an external data source. On board innovated OLED display inside the Data Enabler allows selecting of over 30 static and dynamic color sequences. Display encased behind temperproof UV protected glass to reduce deterioration after long exposure to outdoor environments.

Color Mixing: Using InternaMix™ proprietary technology, colors are efficiently blended together through an internal mixing chamber. The one-color output reduces unsightly views of isolated Red, Green and Blue Diodes for a seamless rainbow-free appearance.

LUMEN MAINTENANCE

L70 Life: 35,000 Hours for ambient temperatures under 100°F.

PHYSICAL

Dimensions (Height x Width x Length): 3-3/8" x 5-1/8" x 24-3/8"

Housing Material: Extruded aluminum to protect light emitting diodes, other electronics and preserve optical alignment. Painted black to maximize color mixing and eliminate stray light leaks.

Weight: 5.7lbs.

Lens: Tempered Glass

Connections: Proprietary miniature 3-pin watertight DMX connection for easy daisy-chain connections up to 2.5 feet on center [32 links max]

Mounting: Includes mounting bracket, each end

Temperature Range: 14°F - 113°F Ambient

Luminaire Run Lengths: Maximum 9 units on power daisy chain, 32 units on DMX daisy chain

CERTIFICATION

Complies to UL1598 and ANSI/UL 8750. IP66

WARRANTY

3-Year Warranty

PHOTOMETRY

FOOTCANDLE CALCULATION: SS2-RGB-3L-12-B45

Height	FC	Ø @ 50% of beam	Ø @ 90% of beam
4'	100	11'	20'
6'	47	16'	30'
8'	27	25'	35'
10'	18	27'	50'
12'	12	31'	60'

