

ColorFlush - Ceiling (H-Series)
SR6LED21
 6" RGBW RECESSED Downlight
DMX/BLUETOOTH

CAT. NO.: _____
 TYPE: _____
 PROJECT: _____

APPLICATION

For the use of direct ambient and/or accent lighting. To install as recessed in ceilings. Perfect for applications desiring a dynamic color changing effect. Recommended for retail, modern residential, hospitality and entertainment installations. RGBW design allows fine-tuned pastel colors, saturated hues without sacrificing illumination brightness.

- 20W 1,255 Max. Lumen
- DMX control via Dip switch selection via Remote Data Enabler
- IP62 Rated
- Proprietary quick connectors included
- Die-Cast 316L Stainless Steel
- LED Die Colors: RGBW
- Static Colors Available

- Using InternaMix™ proprietary technology, colors are efficiently blended together through an internal mixing chamber. The one-color output reduces unsightly views of isolated rainbow-like striations.
- Smooth and flicker-free dimming of all colors down to 1% using patented color mixing and dimming technologies developed at Philips Color Kinetics®
- 3 Year Warranty



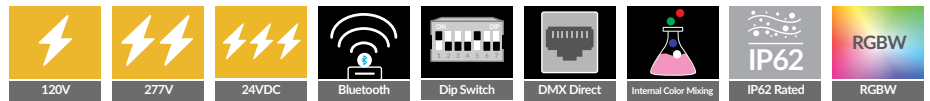
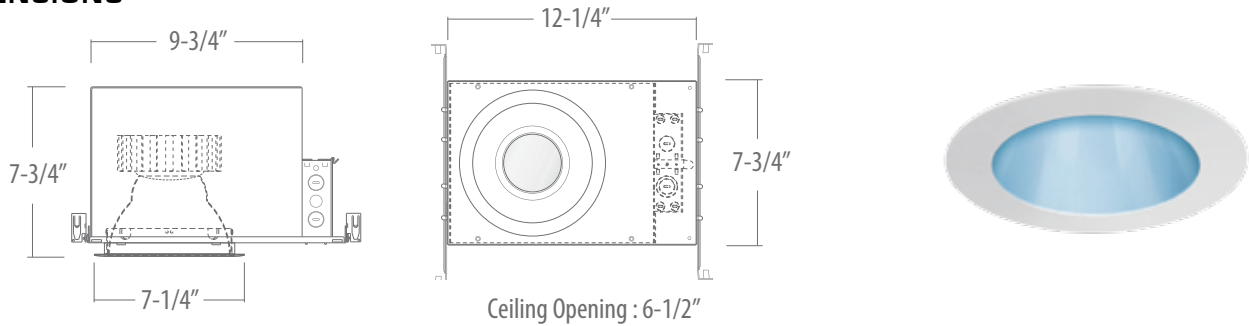



DIMENSIONS



ORDERING – Example: SH6LDV024-WALIB/SR6LED21BB-PWM

HOUSING	POWER INPUT	CONTROL	FINISH
SH6LD	VO24: 24V C7ORGBW-PWM: 120V-277V	Blank: DMX -WALIB: Wireless Bluetooth	/ SR6LED21BB-PWM: Black / SR6LED21WW-PWM: White

ACCESSORIES

72" RJ45 Extension • SWR2RJ45-BK-72	SWR2RJ45-BK-72 	RJ45 Coupler • PCL004	PCL004 
RJ45 DMX Terminator • PCL002	PCL002 	T-Bar/Wood Joist Hanger Bars • HB24	HB24 
DMX RJ45/Terminal Block Coupler • PCL003	PCL003 	200W 4-Channel Data Enabler • SDEBT-24VRGBW-400	SDEBT-24VRGBW-400 

SPECIFICATIONS

OUTPUT

Beam Angle: 60°

Lumens: 1,255 Max. Lumen

Efficacy (lm/W): 62.75 lm/W

LED Channels: Red/Green/Blue/White

ELECTRICAL

Input Voltage: 120V, 277V, and 24V DC available

Power Consumption: 0.1-20W

CONTROL

Interface: DMX Control via dip switch selection via Remote Data Enabler

Control System: DirectDMX Color Control. Color controlled with USITT DMX512A Standard Protocol to work with Coloronix or 3rd Party DMX Systems. DMX Data fed to housing via proprietary 3-wire data cable. Data Input/Output ports allow daisy-chaining of DMX Signal.

LED Die Colors: Red (620-635nm), Green (520-535nm), Blue (450-465nm) and Neutral White (4000k)

Static Color Available: All Standard Colors, Consult Factory.

Dimming: Smooth and flicker-free dimming of all colors down to 1% using Patented Color Mixing and Dimming technologies developed at Philips Color Kinetics[®]

Color Mixing: Using InternaMix[™] proprietary technology, colors are efficiently blended together through an internal mixing chamber. The one-color output reduces unsightly views of isolated Red, Green and Blue Diodes for a seamless rainbow-free appearance.

Wireless Bluetooth Control: Bluetooth control via wireless data enabler. Call up standard colors or shows. One Bluetooth enabler per zone. Each fixture is individually controlled. Not recommended for large scale installations or where programming requires intensive dynamic color syncing across fixtures.

LUMEN MAINTENANCE

L70 Life: 35,000 Hours for ambient temperatures under 85°F.

PHYSICAL

Dimensions (Height x Width x Length): 7-3/4" x 7-3/4" x 12-1/4"

Housing Material: Made of heavy gauge cold-rolled steel to protect light emitting diodes, other electronics and preserve optical alignment. Integral junction box provides easy access for electrical maintenance, via remodeling clips. Die-Cast construction trim ring flange covers ceiling opening. Steel Blades/Springs installed on trim for a tight gap-free installation onto housings. Recommended for ceiling thickness up to 0.75".

Lens: Polycarbonate

Connections: Standard wiring for power in, RJ45 for DMX In/Out

Mounting: Steel pressure springs mounted on trim to ensure positive retention inside housing

Temperature Range: 0°F - 120°F Ambient

CERTIFICATION

ETL Listed Complies to UL1598 and ANSI/UL 8750.
Damp Location Rated. IP62 Protection.

WARRANTY

3-Year Warranty